

KeraTwin K15 / K18

NICHT SICHTBARE BEFESTIGUNG MIT HORIZONTALER SYSTEMSCHIENE
INVISIBLE FASTENING WITH HORIZONTAL SYSTEM RAIL
FIXATION NON-APPARENTE PAR RAIL SYSTEME HORIZONTAL

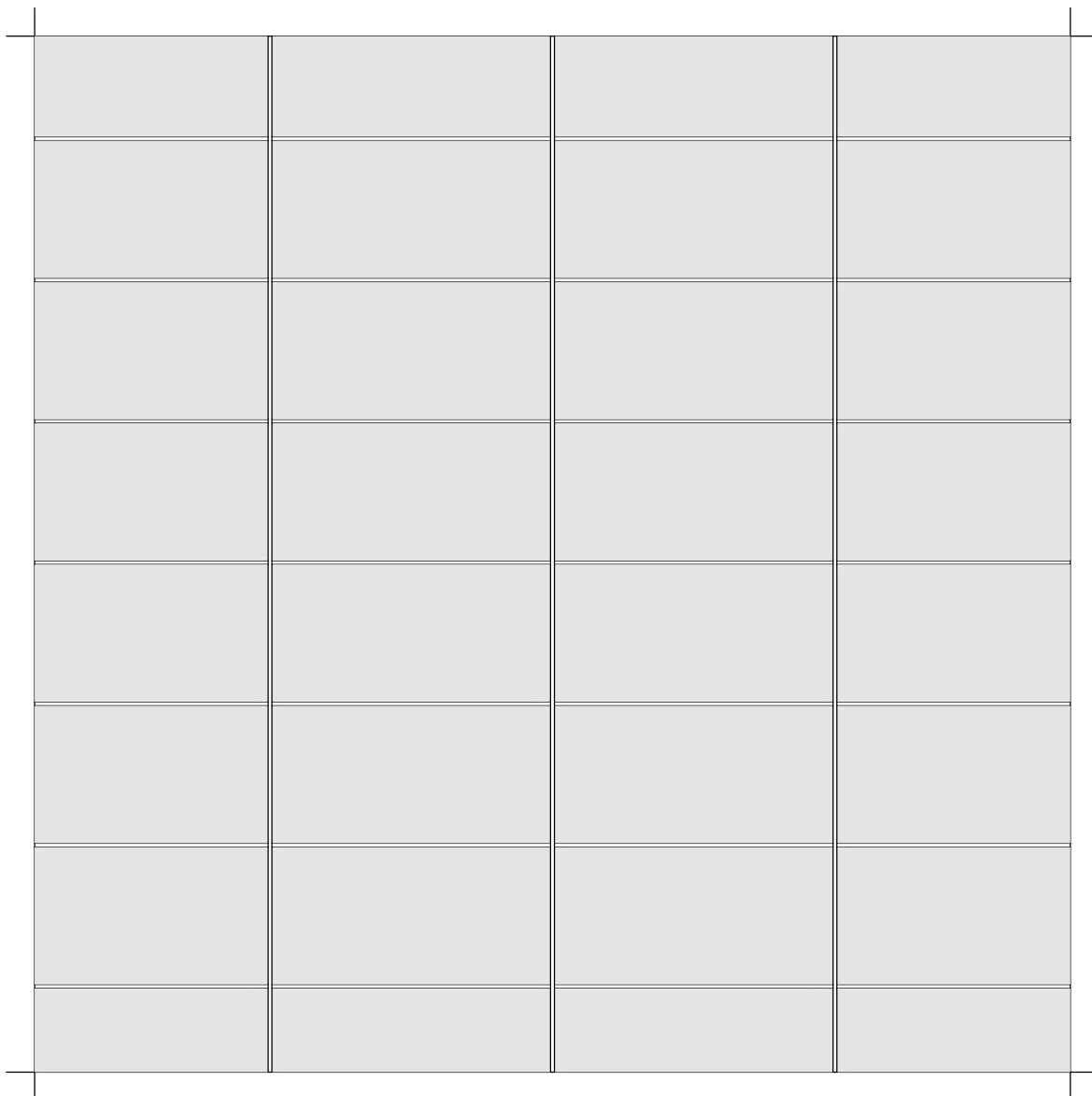

WEITERE OBJEKTSPEZIFISCHE DETAILS AUF ANFRAGE
FURTHER PROJECT-RELATED DETAILS UPON REQUEST
D'AUTRES DETAILS RELATIFS AU PROJET SUR DEMANDE

SYSTEMÜBERSICHT

SYSTEM SCHEME

SYSTEME - VUE D' ENSEMBLE

KERATWIN K15 / K18 - HORIZONTALE SYSTEMSCHIENE

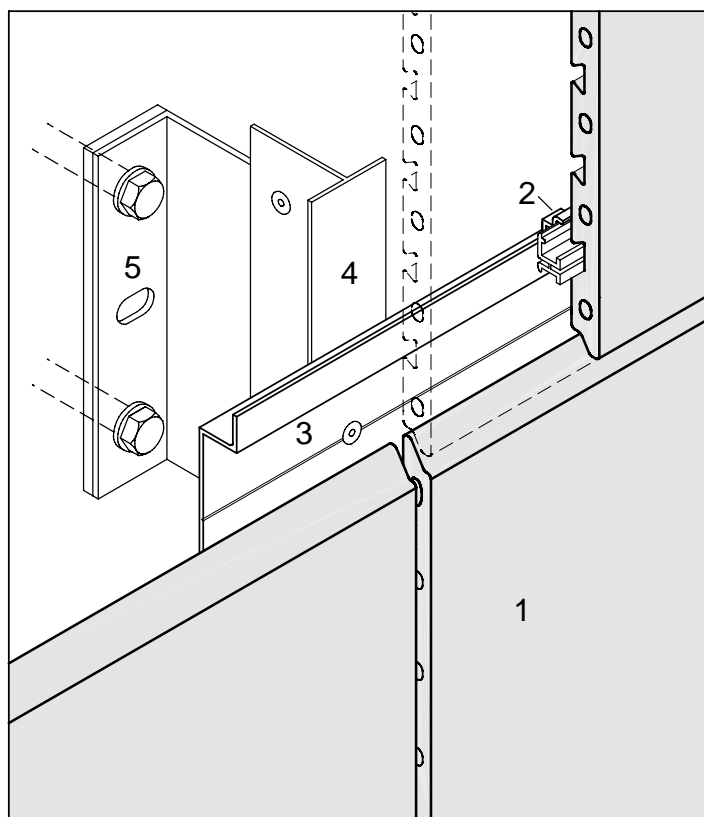

- 1 - KERATWIN K15 / K18 - FASSADENPLATTE
- 2 - KOMPLETT -ADAPTER
- 3 - HORIZONTALE SYSTEMSCHIENE
- 4 - VERTIKALES TRAGPROFIL
- 5 - ALUMINIUM-WANDHALTER

- 1 - KERATWIN K15 / K18 - PANEL
- 2 - COMPLETE ADAPTER
- 3 - HORIZONTAL SYSTEM RAIL
- 4 - VERTICAL BEARING PROFILE
- 5 - ALUMINIUM WALL BRACKET

- 1 - DALLE KERATWIN K15 / K18
- 2 - ADAPTATEUR COMPLET
- 3 - RAIL SYSTEME HORIZONTAL
- 4 - PROFILE PORTEUR VERTICAL
- 5 - PIECE DE SUPPORT MURAL EN ALUMINIUM

SYSTEMSCHNITT VERTIKAL

VERTICAL SECTION
COUPE VERTICALE

KeraTwin K15 / K18

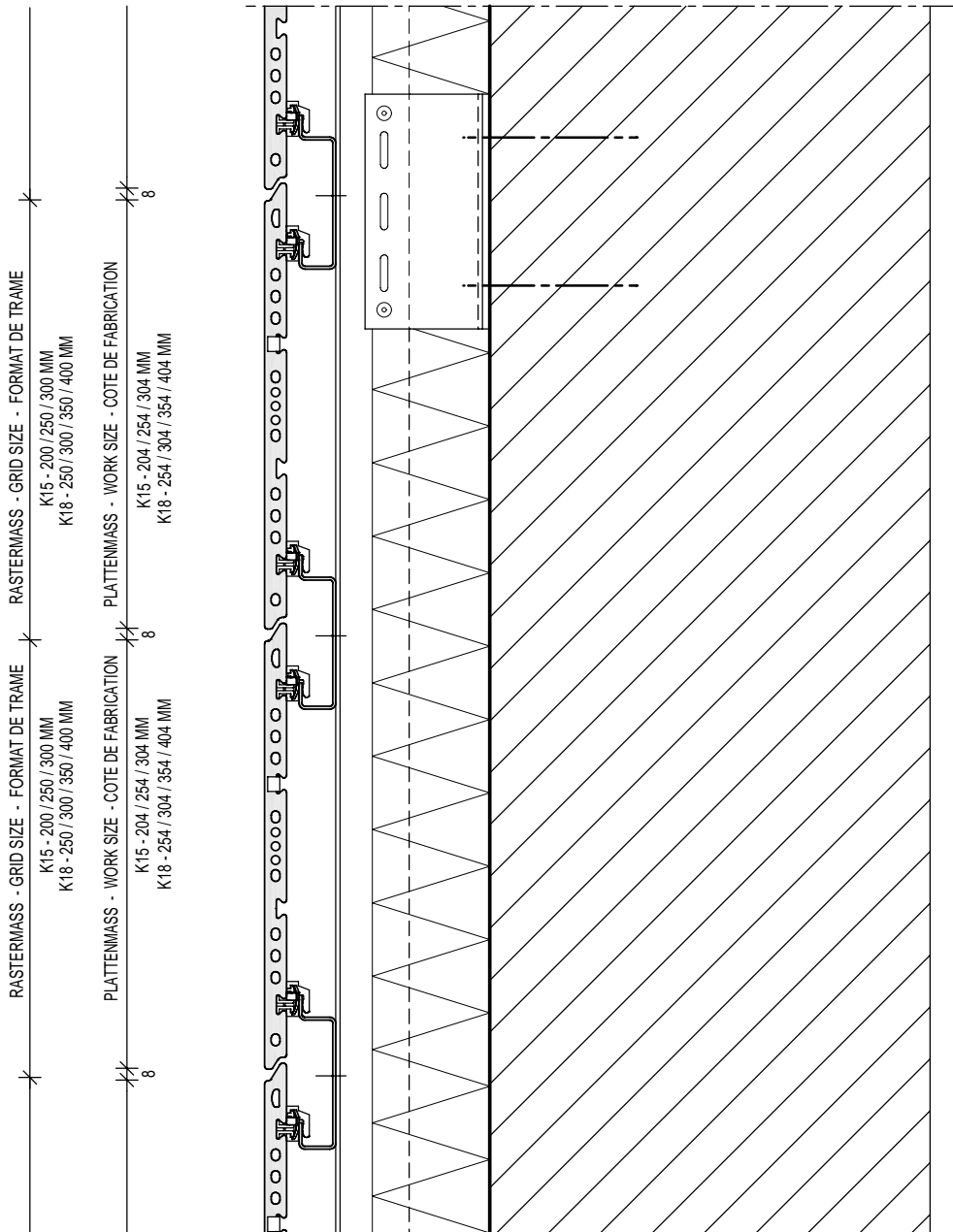

PROFILSTOSS

BUTT-JOINT OF PROFILES

RACCORDEMENT DES PROFILS

KeraTwin K15 / K18

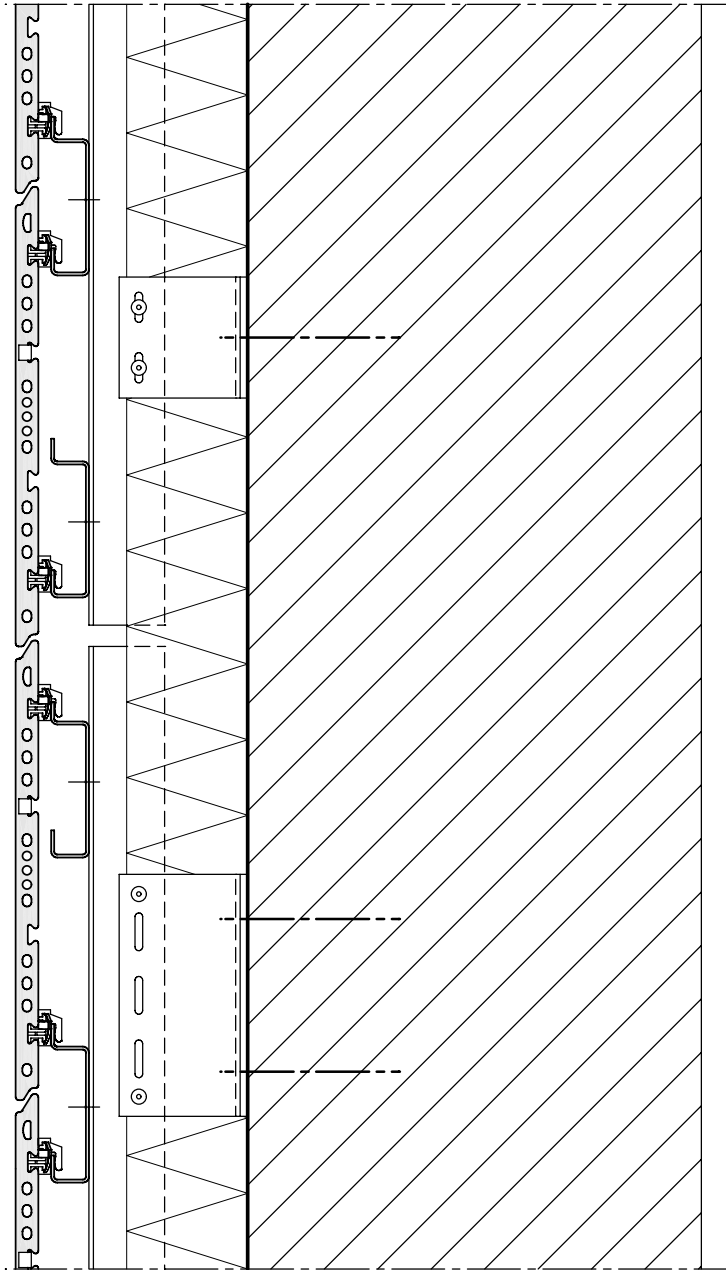

AUSSENECKE MIT GEHRUNGSPLATTEN

EXTERNAL ANGLE WITH MITRED TILES
ANGLE EXTERIEUR AVEC CARREAUX EN BIAIS

KeraTwin K15/ K18

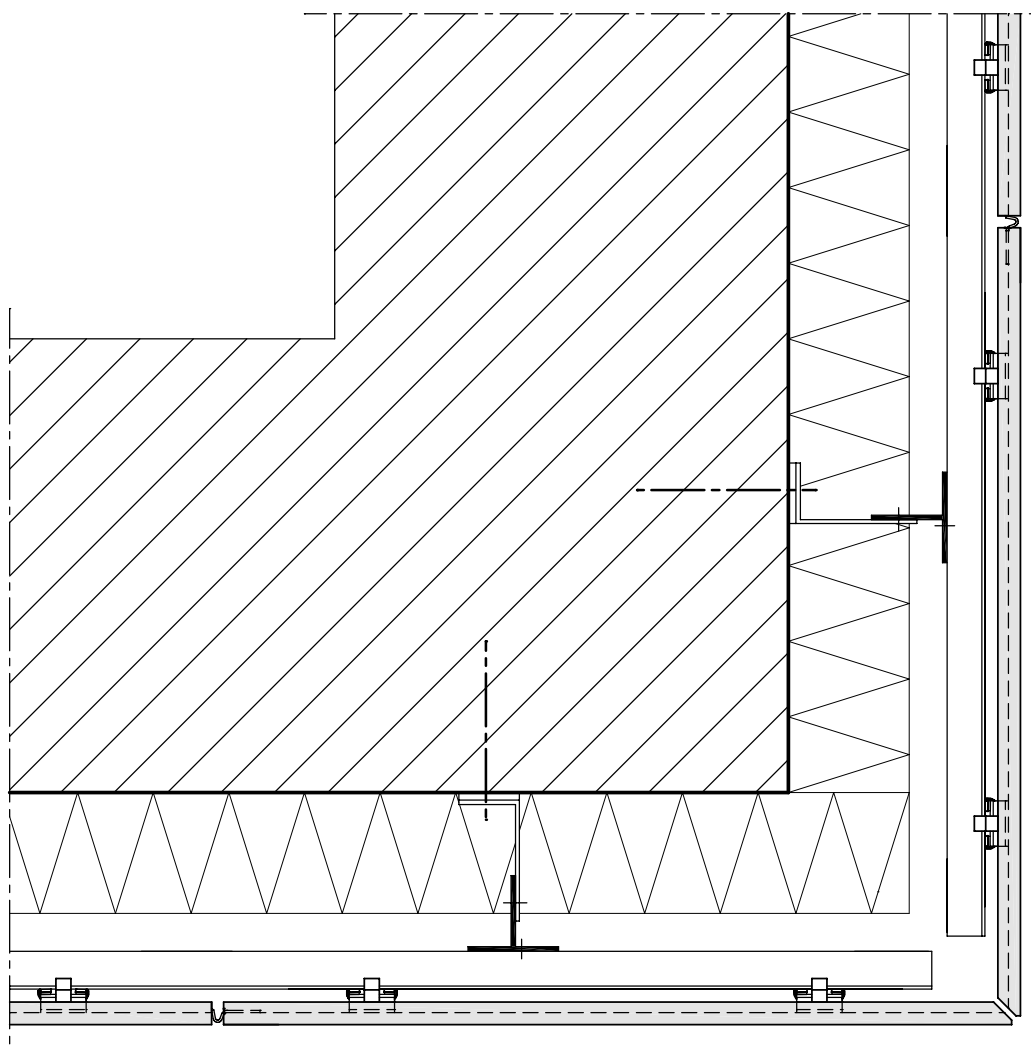

AUSSENECKE MIT ECKPROFIL

EXTERNAL ANGLE WITH CORNER PROFILE
ANGLE EXTERIEUR AVEC PROFILE D' ANGLE

KeraTwin K15/ K18

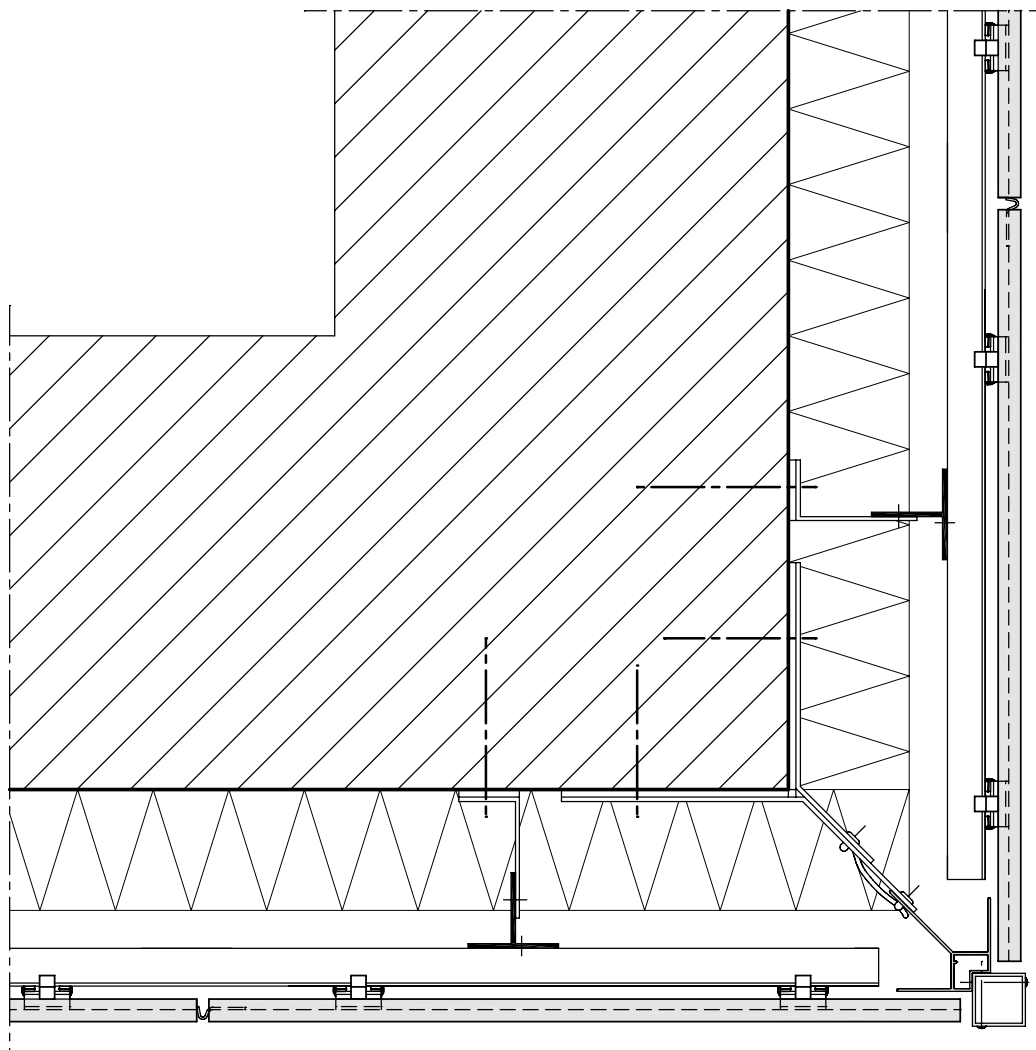

SOCKELANSCHLUSS

CONNECTION TO PLINTH
RACCORD DE SOCLE

KeraTwin K15 / K18

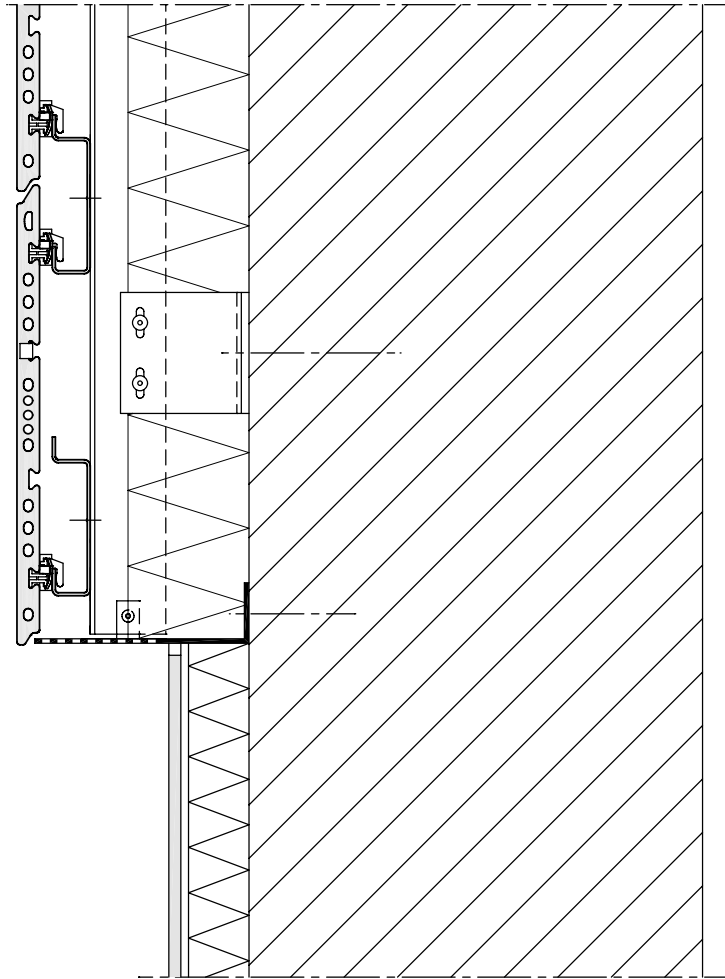

FENSTERSTURZ

WINDOW LINTEL

LINTEAU DE LA FENETRE

KeraTwin K15 / K18

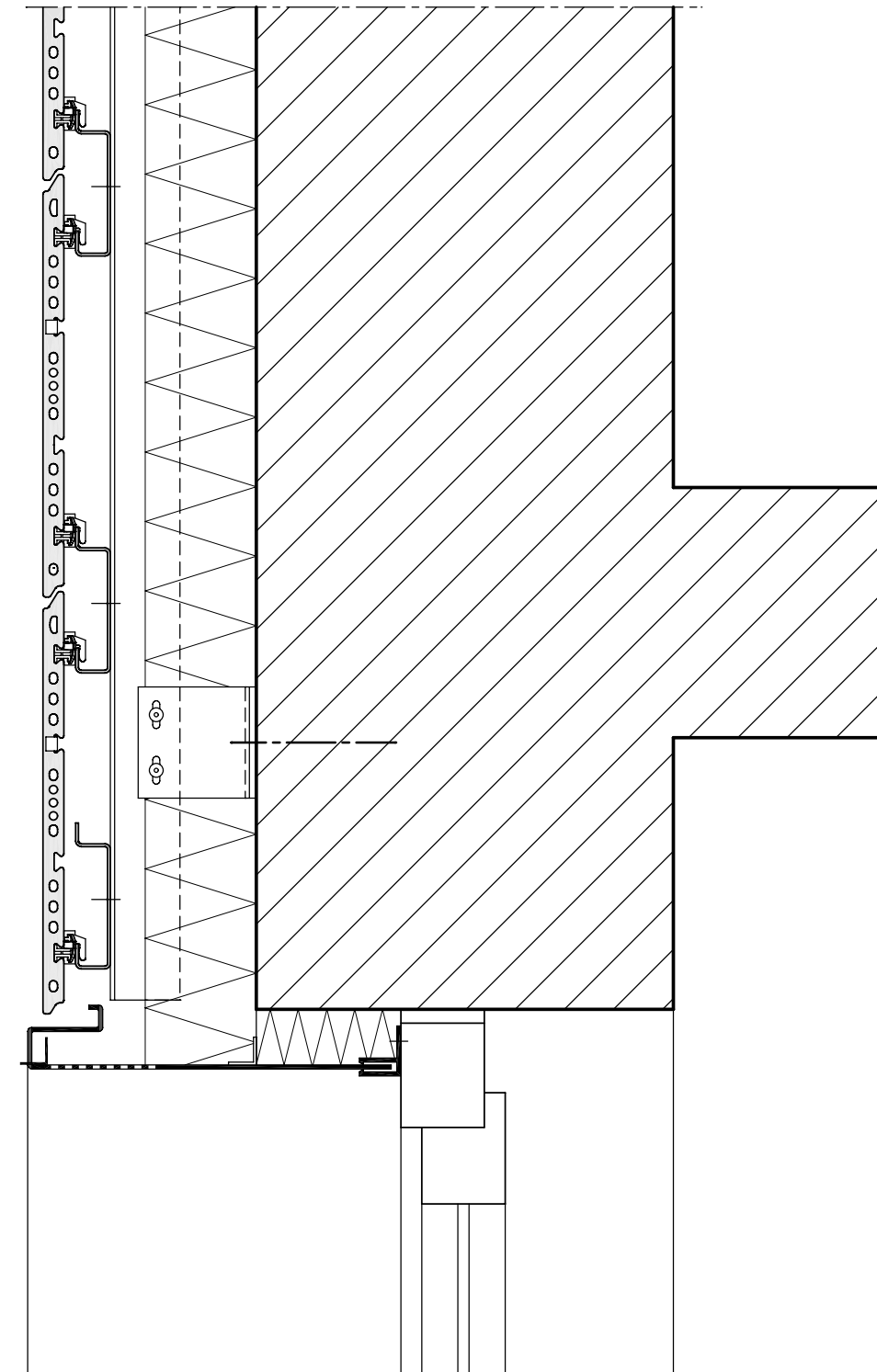

FENSTERBANK

WINDOW SILL
APPUI DE FENETRE

KeraTwin K15 / K18

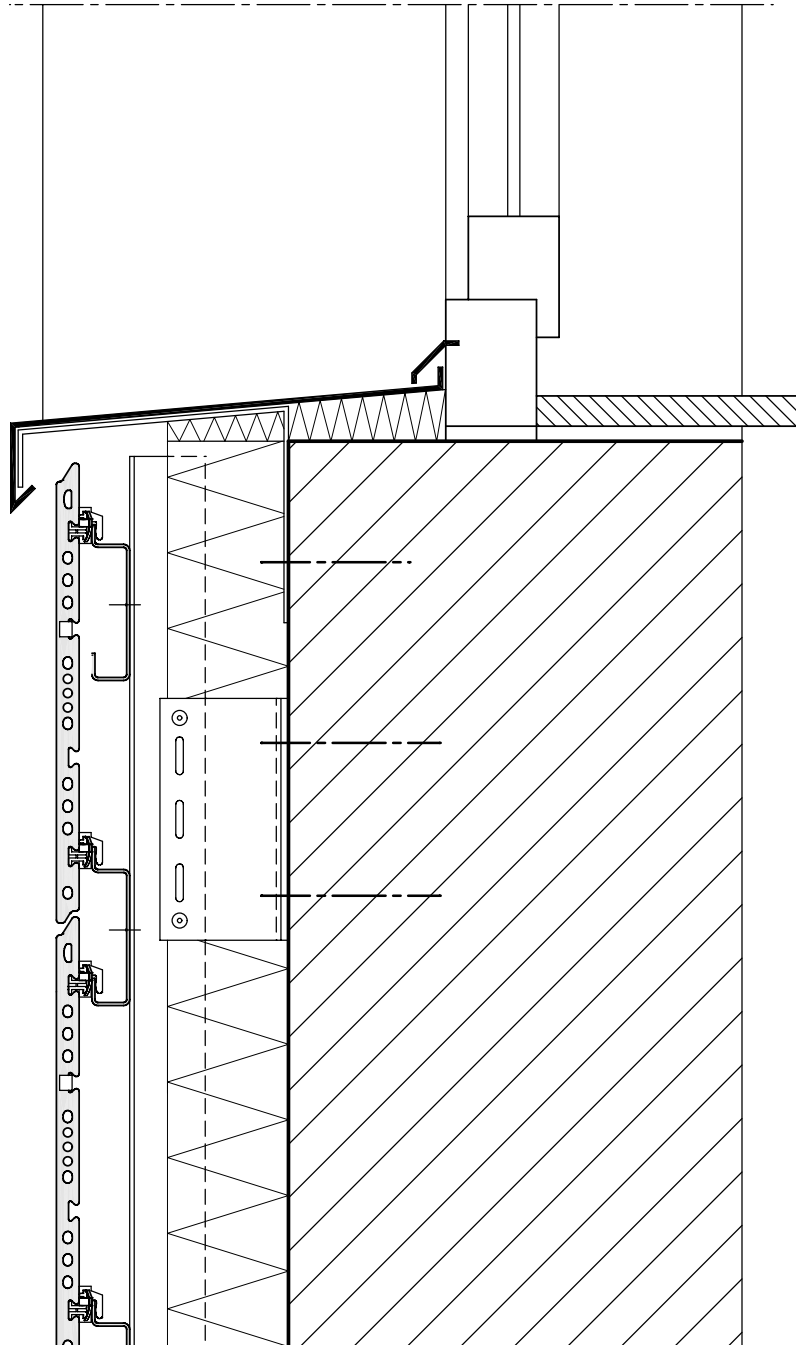

FENSTERLEIBUNG MIT BLECH

EMBRASURE OF THE WINDOW
EMBRASURE DE FENETRE

KeraTwin K15 / K18

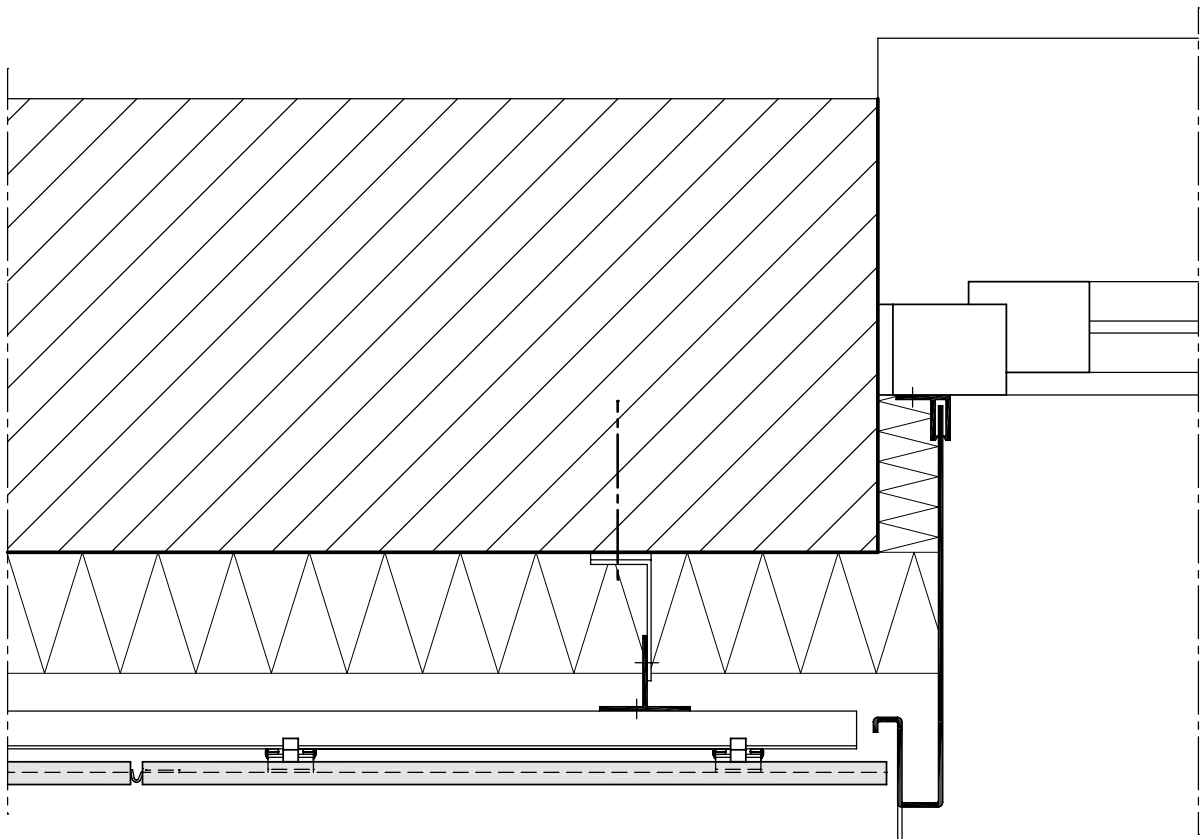

FENSTERLEIBUNG MIT KERATWIN

EMBRASURE OF THE WINDOW WITH KERATWIN

EMBRASURE DE FENETRE AVEC KERATWIN

KeraTwin K15/ K18

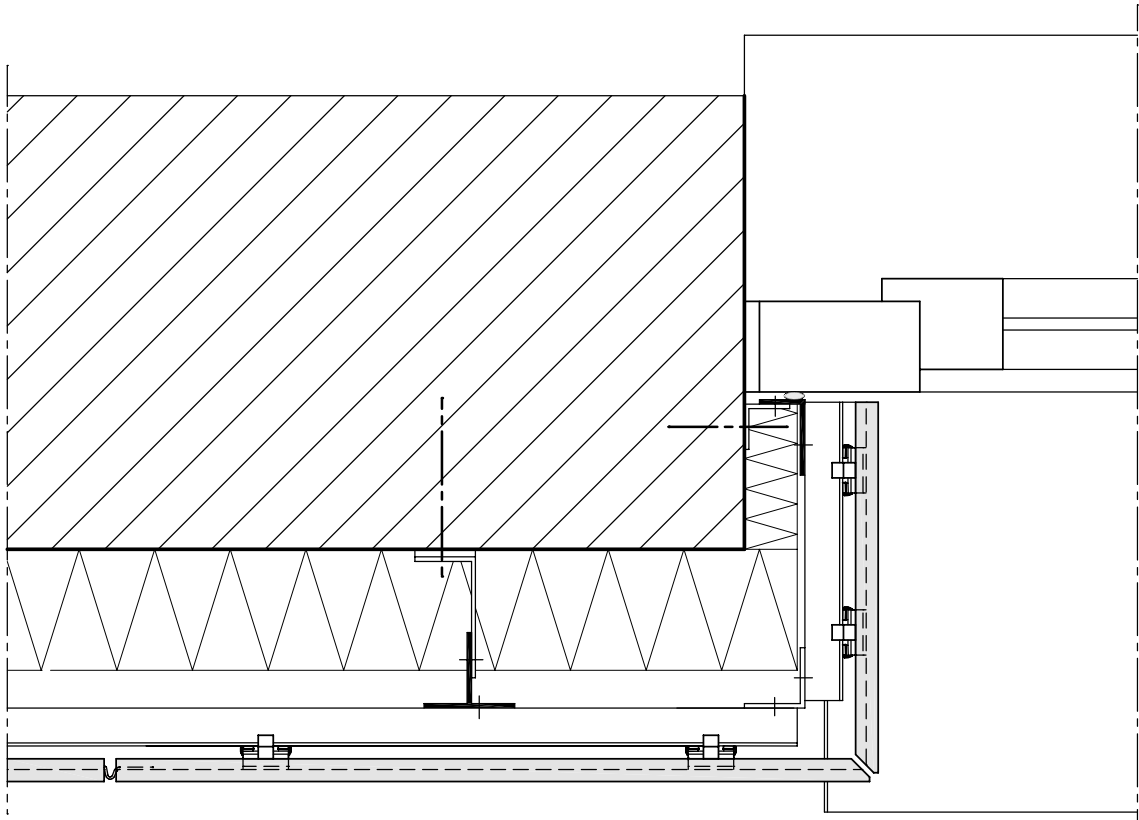

DACHABSCHLUSS

COVERING OF THE ROOF PARAPET
RECOUVREMENT D'ATTIQUE

KeraTwin K15 / K18

